

PRODUCT DATASHEET

SPOT ADJUST 4.50 W 3000 K WT

SPOT ADJUST | Recessed mounted spotlight, adjustable, round shape



Areas of application

- Replacement of halogen lamp spotlights
- General illumination
- Hotel rooms
- Bars, restaurants
- Accent lighting
- Galleries, museums
- Residential interiors

Product benefits

- High luminous efficacy
- Design matches the LEDVANCE DOWNLIGHT luminaire family
- Energy savings of up to 90 % compared to halogen lamp spotlights
- Functional and minimalistic design
- Easy and quick installation
- External driver for extended flexibility (compatible with selected DALI drivers)
- 5 years guarantee

Product features

- Initial color consistency: ≤ 4 SDCM
- Housing material: aluminum
- Lens material: PMMA



TECHNICAL DATA

Electrical data

Nominal wattage	4.50 W
Nominal voltage	220...240 V
Mains frequency	50...60 Hz
Nominal current	20 mA
Max. no. of lum. on circuit break. B16 A	37
Max. no. of lum. on circuit break. C10 A	30
Max. no. of lum. on circuit break. C16 A	48
Power factor λ	> 0.90
Total harmonic distortion	< 15 %
Protection class	II
Operating mode	Electronic control gear (ECG)

Photometrical data

Luminous flux	360 lm
Luminous efficacy	80 lm/W
Color temperature	3000 K
Light color (designation)	Warm White
Color rendering index Ra	> 80
Standard deviation of color matching	≤ 4 sdcn
Photobiological safety group acc. to EN62778	RG0
Photobiological safety group acc. to EN62471	RG0
Beam angle	36 °

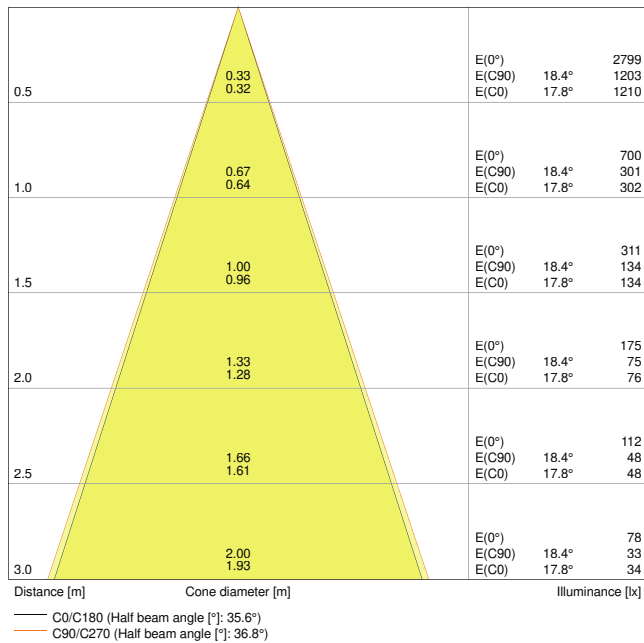

LDC typ cone

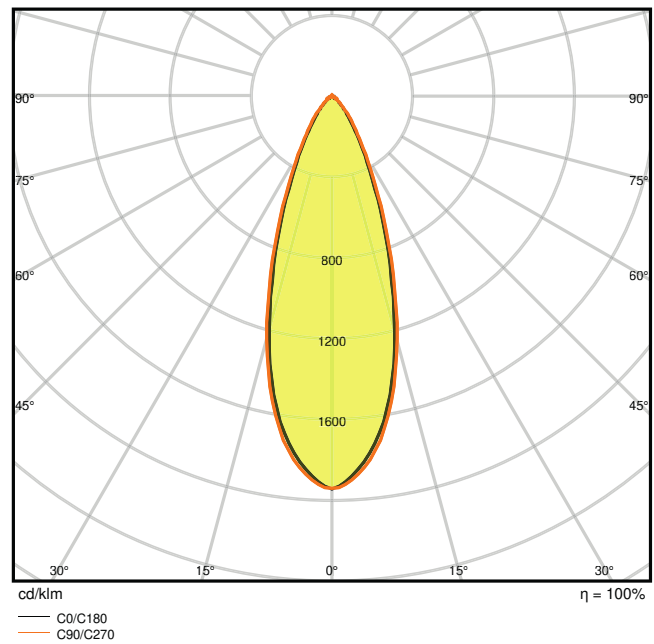

LDC typ polar

Dimensions & Weight

Diameter	80.00 mm
Height	36.00 mm
Product weight	189.00 g

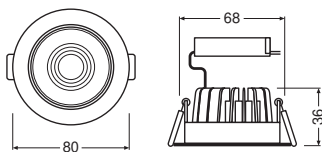

Materials & Colors

Product color	White
Housing color	White
Body material	Aluminum

Light emitting surface material	PMMA
Glow Wire Test according to IEC 60695-2-12	650 °C
Mercury content	0.0 mg

Application & Mounting

Ambient temperature range	-20...+45 °C
Type of connection	Screw terminal, 2-Pole (L,N)
Type of protection	IP20
Protection class IK (shock resistance)	IK06
Dimmable	No
Mounting type	Recessed
Mounting location	Ceiling
Application environment	Indoor
Mounting diameter	68 mm
Mounting depth	90 mm
Adjustable	Yes
LED module replaceable	Not replaceable
With light source	Yes

Lifespan

Lifespan L70/B50 at 25 °C	50000 h ¹⁾
Lifespan L80/B10 at 25 °C	40000 h ¹⁾
Lifespan L90/B10 at 25 °C	20000 h
Number of switching cycles	100000

¹⁾ t[h]: L70 / B50 @ 25 °C (Ta), t[h]: L80 / B10 @ 25 °C (Ta), t[h]: L90 / B10 @ 25 °C (Ta)

Certificates & Standards





Standards	CE / CB / TÜV SÜD / EAC / RoHS
Luminaire with limited surface temperature, "D sign"	No
Ball shot safe	No







DOWNLOAD DATA

Documents and certificates



User instruction

Documents and certificates	
	Addon Technical Information
	On-Pack-Info
	Declarations Of Conformity CE
	Declarations Of Conformity UKCA

Photometric and lighting design files	
	IES file (IES)
	LDT file (Eulumdat)
	ULD file (DIALux)
	ROLF file (RELUX)
	UGR file (UGR table)
	LDC typ cone
	LDC typ polar

LOGISTICAL DATA

Product code	Packaging unit (Pieces/Unit)	Dimensions (length x width x height)	Gross weight	Volume
4058075126886	Folding box 1	110 mm x 105 mm x 65 mm	259.00 g	0.75 dm ³
4058075126893	Shipping box 30	575 mm x 230 mm x 225 mm	8195.00 g	29.76 dm ³

The mentioned product code describes the smallest quantity unit which can be ordered. One shipping unit can contain one or more single products. When placing an order, for the quantity please enter single or multiples of a shipping unit.

ADDITIONAL CATALOG INFORMATION

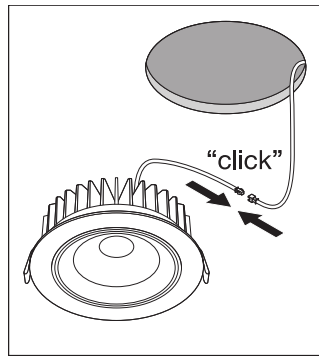
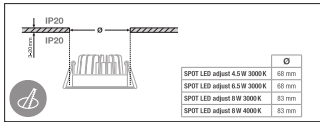

References / Links

- For Guarantee see www.ledvance.com/guarantee

DISCLAIMER

Subject to change without notice. Errors and omission excepted. Always make sure to use the most recent release.