

PRODUCT DATASHEET

SPOT SQUARE DK ADJ 8 W 3000 K WT

SPOT SQUARE DARKLIGHT ADJUST | Recessed mounted spotlight, adjustable, square shape



Areas of application

- Replacement of halogen lamp spotlights
- General accent lighting
- Shops, boutiques
- Hotel rooms
- Bars, restaurants
- Galleries, museums
- Residential interiors

Product benefits

- Cut off angle for comfortable indoor lighting
- High luminous efficacy
- Die-cast aluminum housing for improved heat dissipation
- Energy savings of up to 90 % compared to halogen lamp spotlights
- External driver for extended flexibility (compatible with selected DALI drivers)
- Easy replacement of external driver thanks to plug with bayonet lock
- Design matches the LEDVANCE Spot-, Down- and Tracklight luminaire family
- 5 years guarantee

Product features

- Adjustable tilt angle: +/- 20°
- Initial color consistency: ≤ 4 SDCM



- Lens material: PMMA

TECHNICAL DATA

Electrical data

Nominal wattage	8.00 W
Nominal voltage	220...240 V
Mains frequency	50...60 Hz
Nominal current	65 mA
Inrush current	23 A
Inrush current time T_{h50}	< 3.4 μ s
Max. no. of lum. on circuit break. B16 A	32
Max. no. of lum. on circuit break. C10 A	26
Max. no. of lum. on circuit break. C16 A	41
Power factor λ	> 0.5
Total harmonic distortion	< 15 %
Protection class	II
Operating mode	External LED driver

Photometrical data

Luminous flux	650 lm
Luminous efficacy	90 lm/W
Color temperature	3000 K
Light color (designation)	Warm White
Color rendering index Ra	> 80
Standard deviation of color matching	\leq 4 sdc _m
Luminous intensity	-
Low flicker	Yes
Flickering metric (Pst LM)	-
Stroboscope effect metric (SVM)	-
Photobiological safety group acc. to EN62778	RG0
Photobiological safety group acc. to EN62471	RG0
Beam angle	36 °

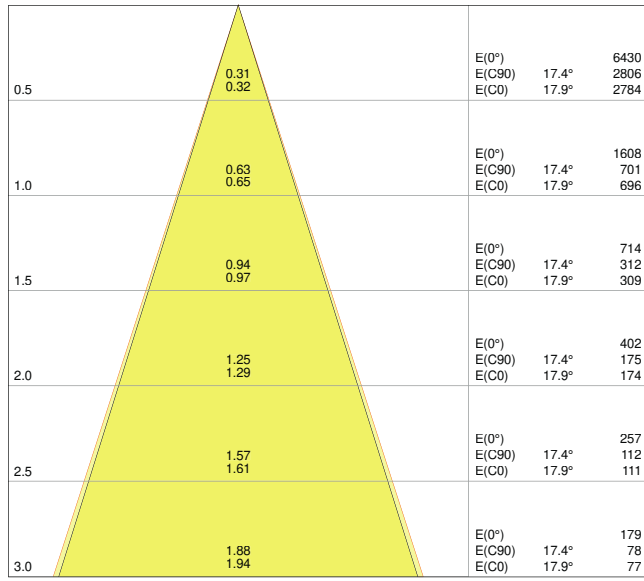

LDC typ cone

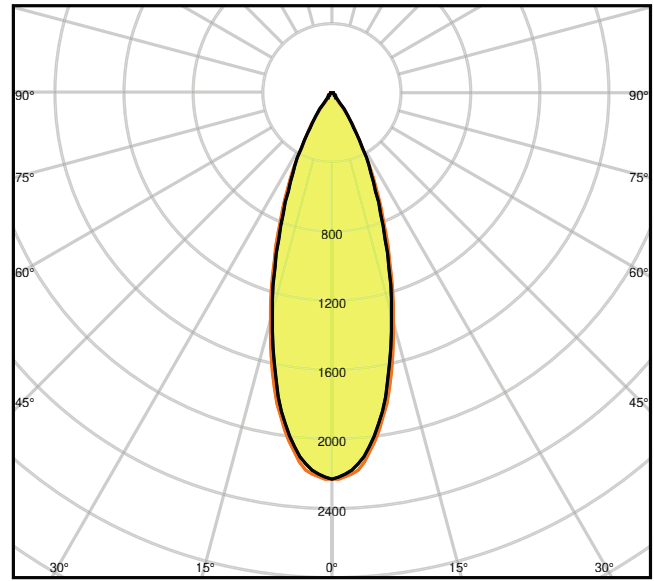

LDC typ polar

Dimensions & Weight

Length	90.00 mm
Width	90.00 mm
Height	72.00 mm
Product weight	230.00 g

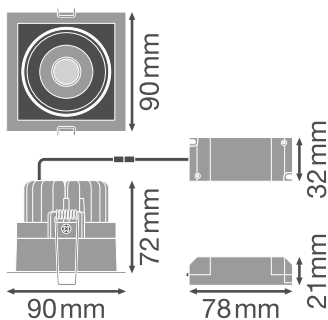

Materials & Colors

Product color	White
Housing color	White
Body material	Aluminum
Cover material	Polymethylmethacrylate (PMMA)
Glow Wire Test according to IEC 60695-2-12	650 °C

Application & Mounting

Ambient temperature range	-10...+40 °C
Type of connection	Screw terminal, 2-Pole (L,N)
Type of protection	IP20
Protection class IK (shock resistance)	IK03
Dimmable	No
Mounting type	Recessed
Mounting location	Ceiling
Application environment	Indoor
Mounting length	83 mm
Mounting width	83 mm
Mounting depth	90 mm
Adjustable	Yes
LED module replaceable	Not replaceable
With light source	Yes

Lifespan

Lifespan L70/B50 at 25 °C	50000 h ¹⁾
Lifespan L80/B10 at 25 °C	45000 h ¹⁾
Lifespan L90/B10 at 25 °C	30000 h
Number of switching cycles	50000

¹⁾ t[h]: L70 / B50 @ 25 °C (Ta), t[h]: L80 / B10 @ 25 °C (Ta), t[h]: L90 / B10 @ 25 °C (Ta)

Control gear

ECG - Length	78 mm
ECG - Width	32 mm
ECG - Height	21 mm

Certificates & Standards

Standards	CE / TÜV SÜD / RoHS / ENEC
-----------	----------------------------





Luminaire with limited surface temperature, "D sign"	No
Ball shot safe	No

EQUIPMENT / ACCESSORIES







- Driver included

DOWNLOAD DATA

Documents and certificates

 PDF	User instruction
 PDF	Addon Technical Information
 PDF	On-Pack-Info
 PDF	Declarations Of Conformity CE
 PDF	Declarations Of Conformity UKCA

Photometric and lighting design files

	IES file (IES)
	LDT file (Eulumdat)
	ULD file (DIALux)
	ROLF file (RELUX)
	UGR file (UGR table)
	LDC typ cone
	LDC typ polar

Tender texts

	Tender documents
---	------------------

LOGISTICAL DATA

Product code	Packaging unit (Pieces/Unit)	Dimensions (length x width x height)	Gross weight	Volume
4058075114043	Folding box 1	105 mm x 110 mm x 115 mm	265.00 g	1.33 dm ³
4058075114050	Shipping box 6	345 mm x 115 mm x 245 mm	1795.00 g	9.72 dm ³

The mentioned product code describes the smallest quantity unit which can be ordered. One shipping unit can contain one or more single products. When placing an order, for the quantity please enter single or multiples of a shipping unit.

ADDITIONAL CATALOG INFORMATION

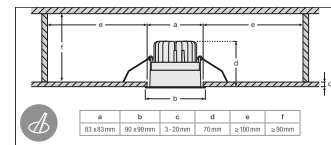
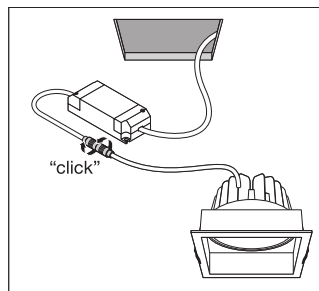
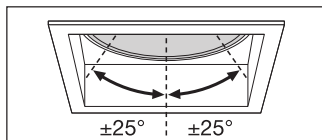

References / Links

- For Guarantee see www.ledvance.com/guarantee

DISCLAIMER

Subject to change without notice. Errors and omission excepted. Always make sure to use the most recent release.